

## FITTING INSTRUCTION

Clamp mark in acc. with		Cables joining
ISO	PN	
1	L	Left directional lights
2	+	Rear fog lights
3	31	Ground
4	R	Right directional lights
5	58R	Right side parking lights
6	54	Stoptlights
7	58L	Left side parking lights

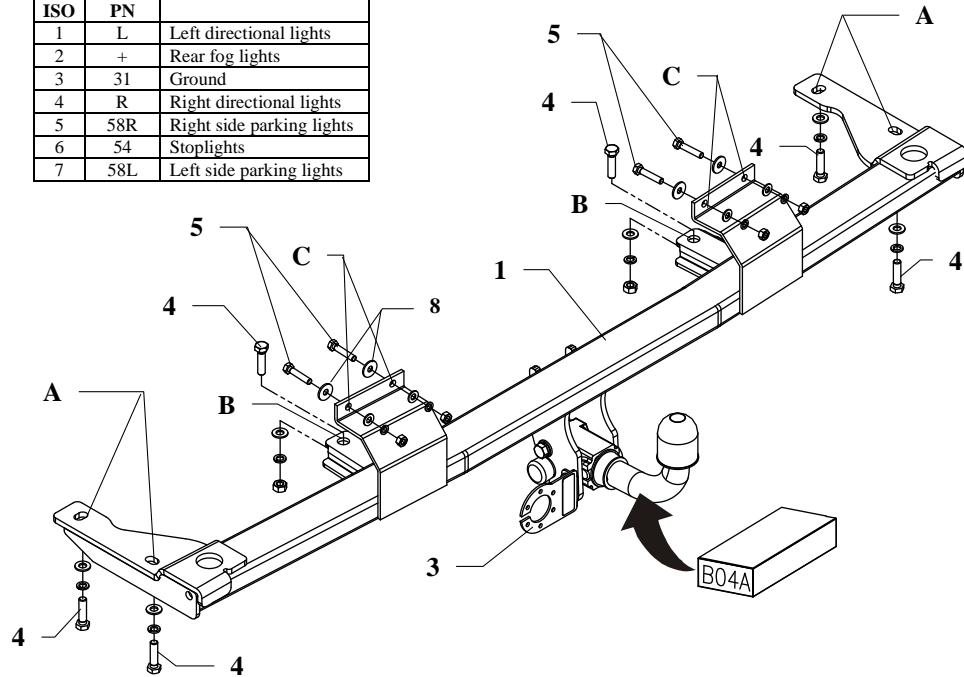

This towbar is designed to assembly in following cars:

**BMW 5 Series E34, 4 door, M5** produced since 01.1988 till 11.1995 and  
**BMW 5 Series E34 Touring, Estate, M5** produced since 01.1991 till  
 03.1997, catalogue number **B04A** and is prepared to tow trailers max total  
 weight **1800 kg** and max vertical load **75 kg**.

### *From manufacturer*

Thank you for buying our product. Their reliability has been confirmed in many tests. Reliability of towbar depends also on correct assembly and right operation. For this reasons we kindly ask to read carefully this instruction and apply to hints.

*The towbar should be install in points described by a car producer.*

## The instruction of the assembly

1. For install the towbar first disassemble the bumper and the cover of the rear plate, inside the carrier.
2. Unscrew the fixing bumper shanks.
3. Apply the main bar of the towbar (pos. 1) underneath the vehicle to the chassis, and across the holes (pos. A and B) fix using bolts M10x40mm (pos. 4) from accessories. Twist loosely.
4. Fix previously unscrewed shanks of the bumper. Attention! In some versions of cars, the shanks can clash with the construction of the towbar. Saw the shanks.
5. Tighten all bolts according to the torque shown in the table.
6. Across the holes in the towbar (pos. C) drill four holes  $\varnothing 9\text{mm}$  to inside the carrier, and then fix with bolts M8x40mm (pos. 5).
7. In the central point of the bowl of the bumper, find a marked place by the factory and cut out a rectangular window, to enter the brackets. In case of difficulty to find it, apply the bumper to the car and measure this place.
8. This prepared bumper twist to the car. Install the rear casing in the carrier.
9. Fix body of the automat and place tow-ball according to supplied instruction. Note! Remember to place socket plate (pos. 3) as shown on the drawing 1.
10. Connect electric wires of 7-poles socket according to the instruction of the car. (Recommend to make at authorized service station)
11. Complete paint layer damaged during installation.

Torque settings for nuts and bolts 8,8:

<b>M 8</b>	25 Nm	<b>M 10</b>	55 Nm
<b>M 12</b>	85 Nm	<b>M 14</b>	135 Nm









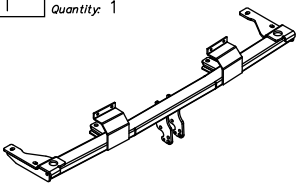

### NOTE

After install the towbar you should get adequate registration in registration book (at authorised service station).The car should be equipment with:

- Indicators
- Tow mirrors

After 1000km check all bolts and nuts. The ball of towbar must be always kept clear and conserve with a grease.

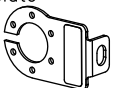
## Towbar accessories:

Pos. 1 Name: Main bar Quantity: 1 	Pos. 4 Name: Bolt 8,8 B Quantity: 6 Dim.: M10x40mm 	Pos. 8 Name: Washer Quantity: 4 Dim.: $\phi 24 \times \phi 8,4 \times 2 \text{mm}$ 
	Pos. 5 Name: Bolt 8,8 B Quantity: 4 Dim.: M8x40mm 	Pos. 9 Name: Plain washer Quantity: 6 Dim.: $\phi 10,5 \text{ mm}$ 
Poz. 2 Tow ball (mounting set) SZTUK:1 	Pos. 6 Name: Nut 8 B Quantity: 2 Dim.: M10 	Pos. 10 Name: Plain washer Quantity: 4 Dim.: $\phi 8,5 \text{ mm}$ 
	Pos. 3 Name: Socket plate Quantity: 1 	Pos. 7 Name: Nut 8 B Quantity: 4 Dim.: M8 
		Pos. 12 Name: Spring washer Quantity: 4 Dim.: $\phi 8,2 \text{ mm}$ 



**PPUH AUTO-HAK S.J.**

Produkcja Haków Holowniczych  
 Henryk & Zbigniew Nejman  
 76-200 SŁUPSK ul. Słoneczna 16K  
 tel/fax (059) 8-414-414; 8-414-413  
 e-mail: [office@autohak.com.pl](mailto:office@autohak.com.pl)  
[www.autohak.com.pl](http://www.autohak.com.pl)

## Towing hitch (without electrical set)

Class: **A50-X** Cat. no. **B04A**

Designed for:

**BMW 5, series E34, M5**

**4 doors - since 01.1988 till 11. 1995**

**BMW 5, series E34 Touring, M5**

**Estate – since 01.1991 till 03. 1997**

Technical data:

**D-value: 9,5 kN**

maximum trailer weight: **1800 kg**

maximum vertical cup load: **75 kg**

**Approval number according to Directive 94/20/EC: e20\*94/20\*0791\*00**

## Foreword

This towbar is designed according to rules of safety traffic regulations. The towing hitch is a safety component and must be installed only by qualified personnel. Any alteration or conversion to the towinh hitch is prohibited and would lead to cancellation of design certification. Remove insulating compound and underseal from vehicle (if present) in the area of the matting surfaces of the towing hitch.

The vehicle manufacturer's specifications regarding trailer load and max. vertical cup load are decisive for driving, and values for the towing hitch cannot be exceeded.

*D-value formula:*

$$\frac{\text{Max trailer weight [kg]} \times \text{Max vehicle weight [kg]}}{\text{Max trailer weight [kg]} + \text{Max vehicle weight [kg]}} \times \frac{9,81}{1000} = D \text{ [kN]}$$