

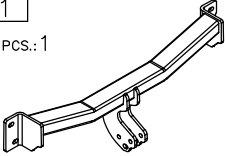









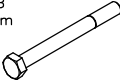

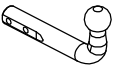
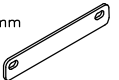

## Towbar accessories:

Pos. 1 Main bar PCS.: 1 	Pos. 5 Left bracket PCS.: 1 	Pos. 10 Bolt 8,8 B M10x110mm PCS.: 4 	Pos. 15 Spring washer ø12,2mm PCS.: 2 
	Pos. 6 Distance sleeve ø17,2x2,35mm L=80mm PCS.: 4 	Pos. 11 Bolt 8,8 B M10x35mm PCS.: 4 	Pos. 16 Spring washer ø10,2mm PCS.: 8 
Pos. 2 Tow ball PCS.: 1 	Pos. 7 Fish-plate 240x40x5mm PCS.: 2 	Pos. 12 Plain washer ø13mm PCS.: 2 	Pos. 17 Nut 8 B M12 PCS.: 2 
Pos. 3 Socket plate PCS.: 1 	Pos. 8 Bolt 8,8 B M12x75mm PCS.: 1 	Pos. 13 Plain washer ø30xø10,5x2,5mm PCS.: 8 	Pos. 18 Nut 8 B M10 PCS.: 8 
Pos. 4 Right bracket PCS.: 1 	Pos. 9 Bolt 8,8 B M12x70mm PCS.: 1 	Pos. 14 Plain washer ø10,5mm PCS.: 4 	Pos. 19 Ball cover PCS.: 1 

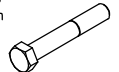

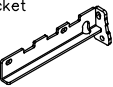
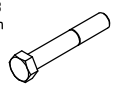
**PPUH AUTO-HAK Sp.J.**

Produkcja Zaczepów Kulowych  
Henryk & Zbigniew Nejman  
76-200 SŁUPSK ul. Słoneczna 16K  
tel/fax (059) 8-414-414; 8-414-413  
E-mail: [office@autohak.com.pl](mailto:office@autohak.com.pl)  
[www.autohak.com.pl](http://www.autohak.com.pl)

## Towing hitch (without electrical set)

Class: **A50-X** Cat. no. **C19**

Designed for:

Manufacturer: **FORD**

Model: **MONDEO**

Type: **4-5 doors**

produced since 09.1996 till 10.2000

Technical data:

**D-value: 8,85 kN**

maximum trailer weight: **1800 kg**

maximum vertical cup load: **75 kg**

**Approval number acc. to regulations EKG/ONZ 55.01: E20-55R-01 0942**

## Foreword

This towbar is designed according to rules of safety traffic regulations. The towing hitch is a safety component and can be install only by qualified personnel. Any alteration or conversion of the towing hitch is prohibited and would lead to cancellation of design certification. Remove insulating compound and underseal from vehicle (if present) in the area of the matting surfaces of the towing hitch.

The vehicle manufacturer's specifications regarding trailer load and max. vertical cup load are decisive for driving whereat values for the towing hitch cannot be exceeded.

*D-value formula:*

$$\frac{\text{Max trailer weight [kg]} \times \text{Max vehicle weight [kg]}}{\text{Max trailer weight [kg]} + \text{Max vehicle weight [kg]}} \times \frac{9,81}{1000} = D \text{ [kN]}$$

## FITTING INSTRUCTION

Clamp mark in acc. with		Cables joining
ISO	PN	
1	L	Left directional lights
2	+	Rear fog lights
3	31	Ground
4	R	Right directional lights
5	58R	Right side parking lights
6	54	Stoplights
7	58L	Left side parking lights

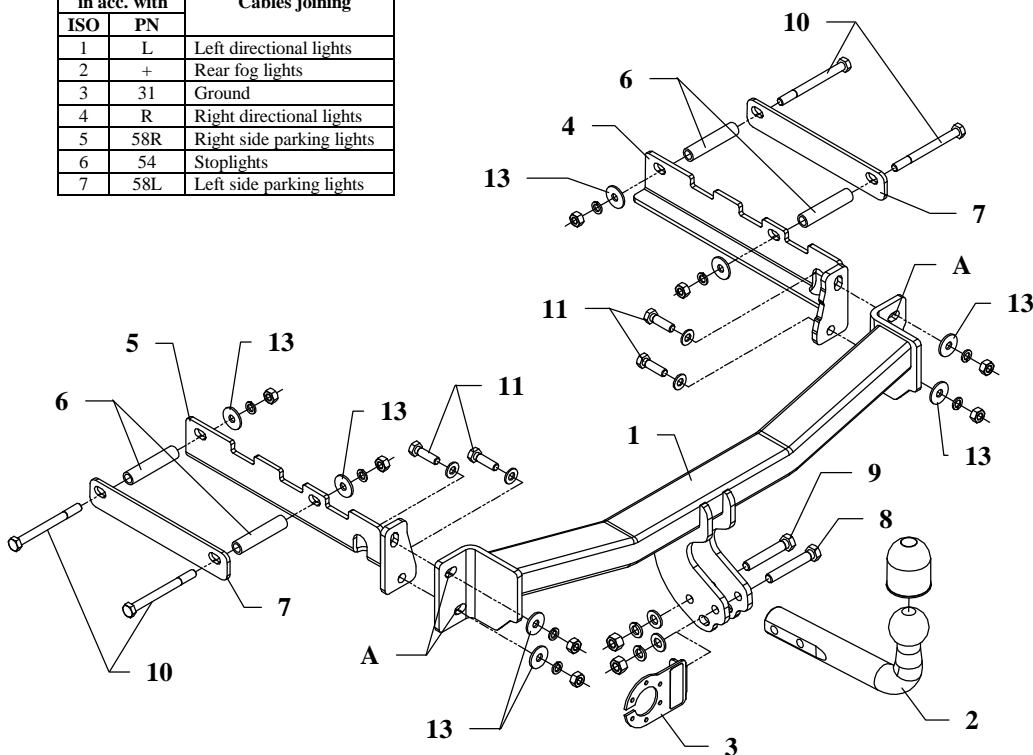

This towbar is designed to assembly in following cars:  
**FORD MONDEO, 4-5 doors**, produced since 09.1996 till 10.2000,  
 catalogue no. **C19** and is prepared to tow trailers max total weight **1800 kg**  
 and max vertical load **75 kg**.

### *From manufacturer*

Thank you for buying our product. Their reliability has been confirmed in many tests. Reliability of towbar depends also on correct assembly and right operation. For this reasons we kindly ask to read carefully this instruction and apply to hints.

*The towbar should be install in points described by a car producer.*

## The instruction of the assembly

1. Disassemble the rear bumper.
2. Slide the sleeves (pos. 6) at the bottom of the car to the chassis members.
3. Position the brackets (pos. 4 and 5) to the left and right inside parts of the chassis, but fish-plates (pos. 7) position outside the chassis then fix it with M10x110mm (pos. 10) through the sleeves (pos. 6).
4. Position the main bar of the towbar (pos. 1) to the rear piece and fix it together with the earlier mounted brackets (pos. 4 and 5) using M10x35mm (pos. 11) through the holes (pos. A).
5. Cut the filling of the bumper (do it in such a way that the bar of the towbar should not clash with the filling of the towbar).
6. Cut the bottom piece of the bumper shown by the car producer and then reassemble the bumper.
7. Tighten all nuts and bolts according to the torque shown in the table.
8. Position the tow ball (pos. 2) with socket plate (pos. 3) and fix with M12x75mm (pos. 8) and M12x70mm (pos. 9) from the towbar accessories.
9. Connect the electric wires according to the instructions of the car.
10. Complete the paint cover of towbar (during the mounting paint cover could be destroyed).

Torque settings for nuts and bolts (8,8):

<b>M6</b> - 11 Nm	<b>M8</b> - 25 Nm	<b>M10</b> - 50 Nm
<b>M12</b> - 87 Nm	<b>M14</b> - 138 Nm	<b>M16</b> - 210 Nm

### NOTE

After install the towbar you should get adequate note in registration book (at authorised service station).The car should be equipped with:

- Indicators
- Tow mirrors

After 1000km of exploitation check all bolts and nuts. The ball of towbar must be always kept clear and conserve with a grease.