

## FITTING INSTRUCTION

Clamp mark in acc. with		Cables joining
ISO	PN	
1	L	Left directional lights
2	+	Rear fog lights
3	31	Ground
4	R	Right directional lights
5	58R	Right side parking lights
6	54	Stoplights
7	58L	Left side parking lights

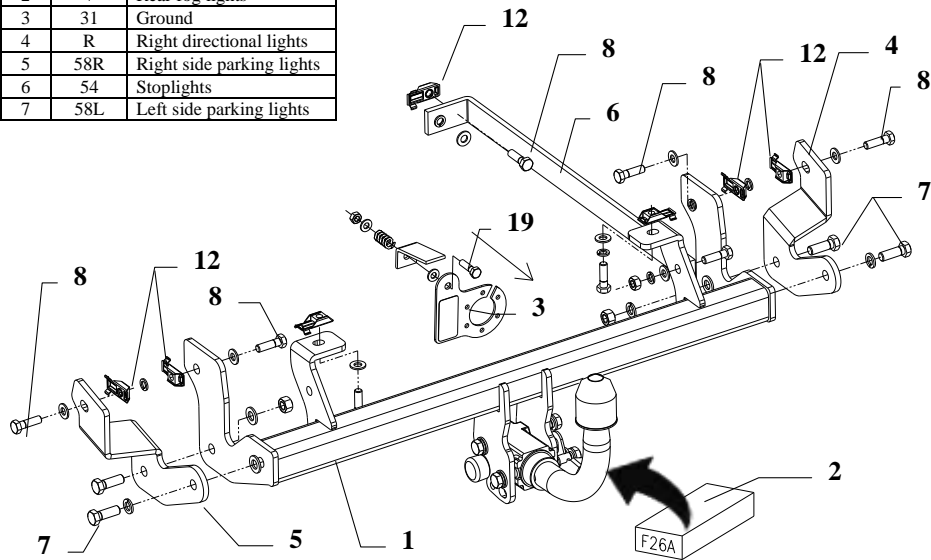

This towbar is designed to assembly in following cars: **Peugeot 807, Fiat Ulysse, Citroen C8, Lancia Z** (all 5 doors and VAN) produced since 09.2002 till 10.2005 and since 11.2005 cat. no. **F26A** and is prepared to tow trailers max total weight **1850 kg** and max vertical load **76 kg**.

### *From manufacturer*

Thank you for buying our product. Their reliability has been confirmed in many tests. Reliability of towbar depends also on correct assembly and right operation. For this reasons we kindly ask to read carefully this instruction and apply to hints.

*The towbar should be install in points described by a car producer.*

### The instruction of the assembly

1. Disassemble the rear bumper .
2. Mounting points are original points described by a car producer. This places are covered by sticker, take them out.

3. To uncovered holes put special nuts „Caget nut” (pos.12).
4. Put mian bar of the towbar in this way, so towbar’s holes agree with caget nut, fix by M10x35mm bolts (pos. 8) as shown on the drawing (loosely).
5. Fix side brackets pos. 4, 5 and flat bar pos. 6 .
6. Cut the bumper according to the fig. 2 and then reassemble it.

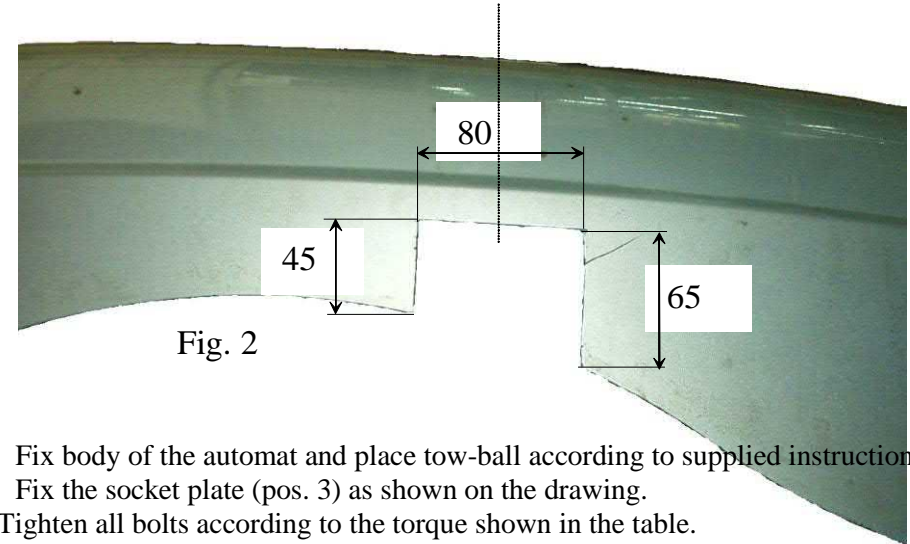

7. Fix body of the automat and place tow-ball according to supplied instruction.
8. Fix the socket plate (pos. 3) as shown on the drawing.
9. Tighten all bolts according to the torque shown in the table.
10. Connect electric wires of 7-poles socket according to the instruction of the car. (Recommend to make at authorized service station)
11. Complete paint layer damaged during installation.

#### Torque settings for nuts and bolts (8,8):

<b>M6</b> - 11 Nm	<b>M8</b> - 25 Nm	<b>M10</b> - 50 Nm
<b>M12</b> - 87 Nm	<b>M14</b> - 138 Nm	<b>M16</b> - 210 Nm











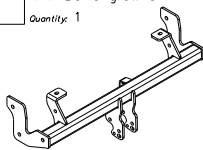







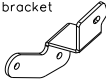

### NOTE

After install the towbar you should get adequate note in registration book (at authorised service station).The car should be equipped with:

- Indicators
- Tow mirrors

After 1000km of exploitation check all bolts and nuts. The ball of towbar must be always kept clear and conserve with a grease.

## Towbar accessories:

Pos. 1 Name: Belka główna Quantity: 1 	Pos. 6 Name: Flat bar Quantity: 1 	Pos. 12 Name: Caget nut Quantity: 7 Dim.: M10 	Pos. 18 Name: Spring Quantity: 1 
Pos. 2 Name: Część kulista Quantity: 1 	Pos. 7 Name: Bolt 8,8 B Quantity: 4 Dim.: M12x35mm 	Pos. 13 Name: Plain washer Quantity: 4 Dim.: Ø 13 mm 	Pos. 19 Name: Bolt 8,8 B Quantity: 1 Dim.: M8x30mm 
Pos. 3 Name: Socket plate Quantity: 1 	Pos. 8 Name: Bolt 8,8 B Quantity: 8 Dim.: M10x35mm 	Pos. 14 Name: Plain washer Quantity: 8 Dim.: Ø 10,5 mm 	Pos. 20 Name: Ball cover Quantity: 1 
Pos. 4 Name: Right bracket Quantity: 1 	Pos. 9 Name: Nut 8 B Quantity: 4 Dim.: M12 	Pos. 15 Name: Plain washer Quantity: 2 Dim.: Ø 8,5 mm 	
Pos. 5 Name: Left bracket Quantity: 1 	Pos. 10 Name: Nut 8 B Quantity: 1 Dim.: M10 	Pos. 16 Name: Spring washer Quantity: 4 Dim.: Ø 12,2 mm 	
	Pos. 11 Name: Nut 8 B Quantity: 1 Dim.: M8 	Pos. 17 Name: Spring washer Quantity: 8 Dim.: Ø 10,2 mm 	



**PPUH AUTO-HAK S.J.**

Produkcja Zaczepów Kulowych  
Henryk & Zbigniew Nejman  
76-200 SŁUPSK ul. Słoneczna 16K  
tel/fax (059) 8-414-414; 8-414-413  
E-mail: [office@autohak.com.pl](mailto:office@autohak.com.pl)  
[www.autohak.com.pl](http://www.autohak.com.pl)

## Towing hitch (without electrical set)

Class: **A50-X** Cat. no. **F26A**

Designed for:

**Peugeot 807 – 5 doors, VAN**

**Fiat Ulysse – 5 doors, VAN (179),**

**Citroen C8 – 5 doors, VAN,**

**Lancia Z – 5 doors, VAN (179)**

produced since 09.2002 till 10.2005 and since 11.2005

Technical data:

**D-value: 10,44 kN**

maximum trailer weight: **1850 kg**

maximum vertical cup load: **76 kg**

Approval number according to Directive 94/20/EC: **e20\*94/20\*0800\*00**

## Foreword

This towbar is designed according to rules of safety traffic regulations. The towing hitch is a safety component and must be installed only by qualified personnel. Any alteration or conversion to the towing hitch is prohibited and would lead to cancellation of design certification. Remove insulating compound and underseal from vehicle (if present) in the area of the matting surfaces of the towing hitch.

The vehicle manufacturer's specifications regarding trailer load and max. vertical cup load are decisive for driving, and values for the towing hitch must not be exceeded.

*D-value formula:*

$$\frac{\text{Max trailer weight [kg]} \times \text{Max vehicle weight [kg]}}{\text{Max trailer weight [kg]} + \text{Max vehicle weight [kg]}} \times \frac{9,81}{1000} = D \text{ [kN]}$$