

FITTING INSTRUCTION

Clamp mark in acc. with		Cables joining
ISO	PN	
1	L	Left directional lights
2	+	Rear fog lights
3	31	Ground
4	R	Right directional lights
5	58R	Right side parking lights
6	54	Stoptights
7	58L	Left side parking lights

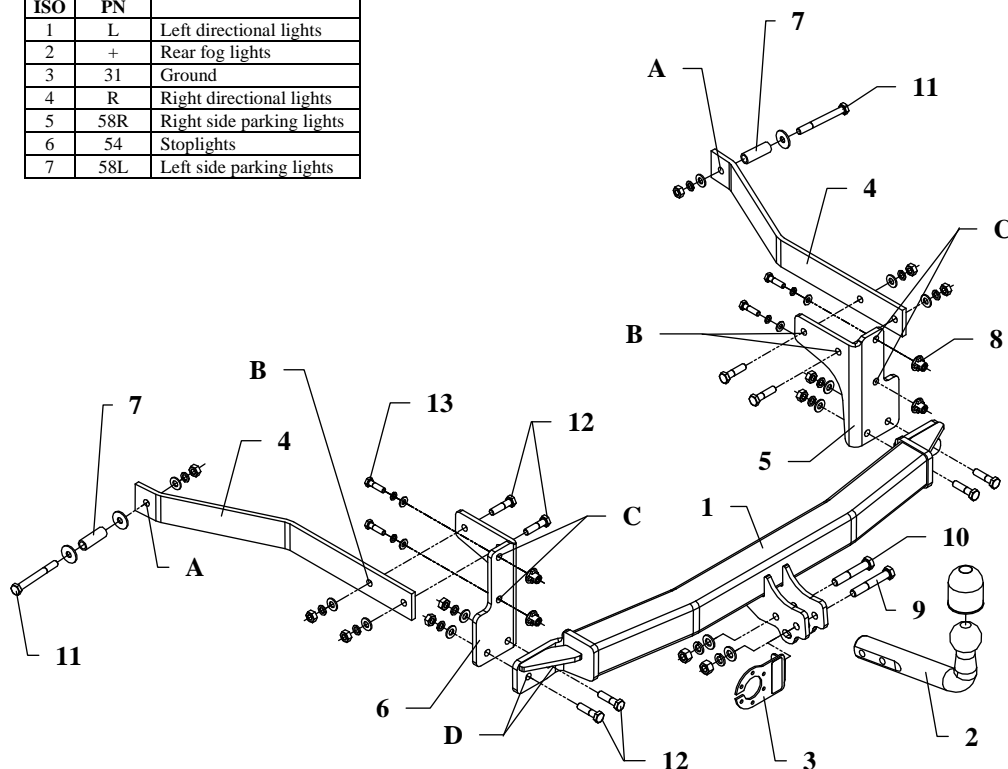

This towing hitch is designed to assembly in following car:
RENAULT LAGUNA ESTATE, produced since 08.1995 till 03.2001,
 catalogue no. **G19** and is prepared to tow trailers max total weight **1850 kg**
 and max vertical load **75 kg**.

From manufacturer

Thank you for buying our product. Their reliability has been confirmed in many tests. Reliability of towing hitch depends also on correct assembly and right operation. For this reasons we kindly ask to read carefully this instruction and apply to hints.

The towing hitch should be install in points described by a car producer.

The instruction of the assembly

1. To install the towing hitch it is not necessary reassemble a bumper but you have to reassemble rear handle of the muffler.
2. Put distance sleeves from accessories (pos. 7) into chassis members on either sides.
3. From below of car put four baskets with nuts – pos. 8 (two per side) in existing holes in rear piece.
4. Fix side brackets (pos. 4) with bolts M10x90mm (pos. 11) through holes (pos. A) and through distance sleeves in chassis members.
5. To mounted brackets fix angle brackets (pos. 5 and 6) through holes (pos. B) with bolts M10x40mm (pos. 12), and next through holes (pos. C) fix it to the rear piece of the car using bolts M8x30mm (pos. 13).
6. Fix the main bar of the towing hitch (pos. 1) to mounted side brackets using bolts M10x40mm – pos. 12 (through holes pos. D).
7. Fix tow ball (pos. 2) using bolt M12x75mm (pos. 9) and M12x70mm (pos. 10). With bolt M12x75mm fix also a socket plate (pos. 3). See figure 1.
8. Tighten all bolts according to the torque shown in the table.
9. Connect the electric wires according to the instruction of the car. (Recommend to make at service station).
10. Supplement the paint coating damaged during assembly.

Torque settings for nuts and bolts (8,8):	
M 8 - 25 Nm	M 10 - 55 Nm
M 12 - 85 Nm	M 14 - 135 Nm











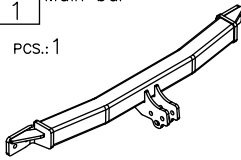





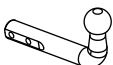

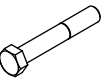

NOTE

After install the towing hitch you should get adequate note in registration book (at authorised service station).The car should be equipped with:

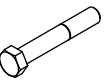
- Indicators
- Tow mirrors

After 1000km check all bolts and nuts. The ball of towing hitch must be always kept clear and conserve with a grease.

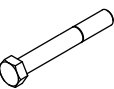
Towing hitch accessories:

Pos. 1 Main bar PCS.: 1 	Pos. 6 Left bracket PCS.: 1 	Pos. 12 Bolt 8,8 B M10x40mm PCS.: 8 	Pos. 18 Plain washer ø30xø10.5x2.5mm PCS.: 3 
	Pos. 7 Distance sleeve ø17.2x2.3mm L=48mm PCS.: 2 	Pos. 13 Bolt 8,8 B M8x30mm PCS.: 4 	Pos. 19 Plain washer ø8.2mm PCS.: 4 
Pos. 2 Tow ball PCS.: 1 	Pos. 8 Special nut M8 PCS.: 4 	Pos. 14 Nut 8,8 B M12 PCS.: 2 	Pos. 20 Spring washer ø12.2mm PCS.: 2 
Pos. 3 Socket plate PCS.: 1 	Pos. 9 Bolt 8,8 B M12x75mm PCS.: 1 	Pos. 15 Nut 8,8 B M10 PCS.: 10 	Pos. 21 Spring washer ø10.2mm PCS.: 10 
Pos. 4 Side bracket PCS.: 2 	Pos. 10 Bolt 8,8 B M12x70mm PCS.: 1 	Pos. 16 Plain washer ø13mm PCS.: 2 	Pos. 22 Spring washer ø8.2mm PCS.: 4 
Pos. 5 Right bracket PCS.: 1 	Pos. 11 Bolt 8,8 B M10x90mm PCS.: 2 	Pos. 17 Plain washer ø10.5mm PCS.: 10 	Pos. 23 Ball cover PCS.: 1 



PPUH AUTO-HAK S.J.

Produkcja Haków Holowniczych
Henryk & Zbigniew Nejman
76-200 SŁUPSK ul. Słoneczna 16K
tel/fax (059) 8-414-414; 8-414-413
E-mail: office@autohak.com.pl
www. autohak.com.pl

Towing hitch (without electrical set)

Class: **A50-X** Cat. no. **G19**

Designed for:

Manufacturer: **RENAULT**

Model: **LAGUNA**

Type: **ESTATE**

produced since 08.1995 till 03.2001

Technical data:

D-value: 9,30 kN

maximum trailer weight: **1850 kg**

maximum vertical cup load: **75 kg**

Approval number acc. to regulations EKG/ONZ 55.01: E20-55R-01 4738

Foreword

This towing hitch is designed according to rules of safety traffic regulations. The towing hitch is a safety component and can be install only by qualified personnel. Any alteration or conversion of the towing hitch is prohibited and would lead to cancellation of design certification. Remove insulating compound and underseal from vehicle (if present) in the area of the matting surfaces of the towing hitch.

The vehicle manufacturer's specifications regarding trailer load and max. vertical cup load are decisive for driving, and values for the towing hitch cannot be exceeded.

D-value formula:

$$\frac{\text{Max trailer weight [kg]} \times \text{Max vehicle weight [kg]}}{\text{Max trailer weight [kg]} + \text{Max vehicle weight [kg]}} \times \frac{9,81}{1000} = D \text{ [kN]}$$