

FITTING INSTRUCTION

Clamp mark in acc. with		Cables joining
ISO	PN	
1	L	Left directional lights
2	+	Rear fog lights
3	31	Ground
4	R	Right directional lights
5	58R	Right side parking lights
6	54	Stoplights
7	58L	Left side parking lights

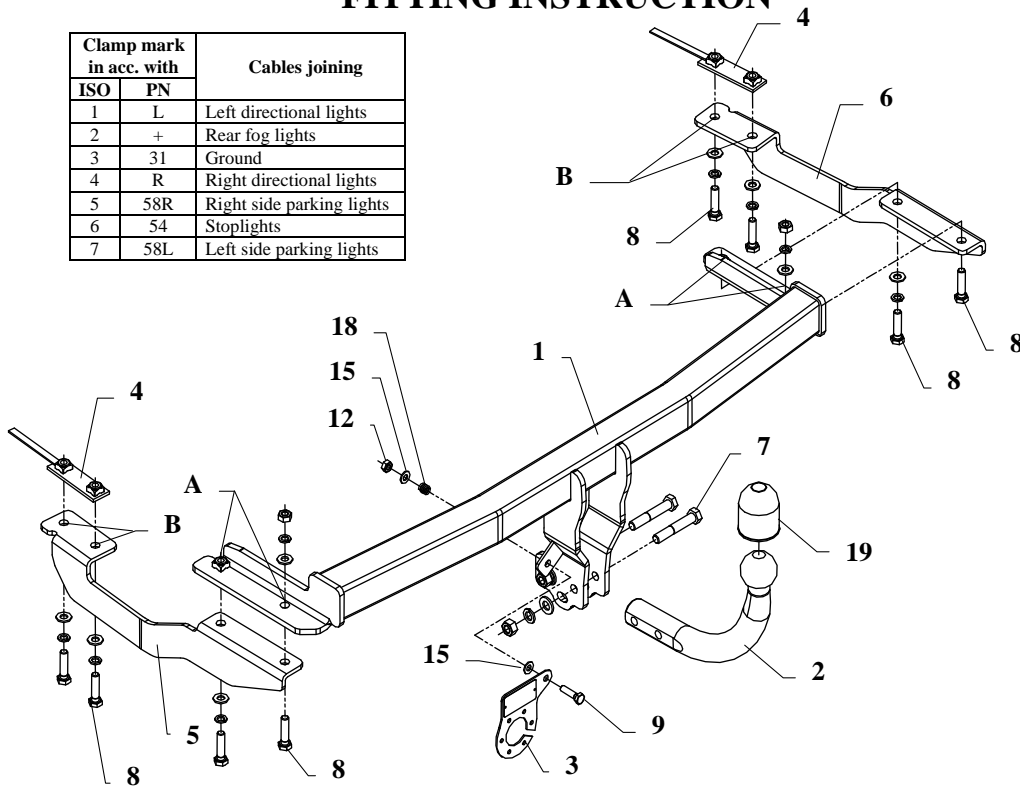

The towing hitch can be used in the following cars:

VW POLO Classic, 4 doors (6N) produced since 10.1995 till 09.1999, **VW POLO Classic, 4 doors (6N2)** produced since 10.1999 till 09.2003, **VW POLO Variant, Estale (6N)** produced since 04.1997 till 09.1999 and produced since 10.1999 till 09.2001, **SEAT CORDOBA 2/4 doors, Coupe, (6K5), CLX, GLX, GTI, SX** produced since 02.1996 till 09.1999 and produced since 10.1999 till 12.2002, **SEAT CORDOBA Vario, Estale (6K5)** produced since 09.1997 till 09.1999 and produced since 10.1999 till 12.2002, catalogue number **K16A** and is prepared to tow trailers max total weight **1200kg** and max vertical load **50kg**.

From manufacturer

Thank you for buying our product. Their reliability has been confirmed in many tests. Reliability of towing hitch depends also on correct assembly and right operation. For this reasons we kindly ask to read carefully this instruction and apply to hints.

The towing hitch should be install in points described by a car producer.

The instruction of the assembly

1. Disassemble the bumper together with the bottom cover, then unscrew the metal bumper support (this part is not useful any more).
2. To chassis members tunnels slide the bar of towing hitch (pos. 1), and position it in such a way that holes (pos. A) are compatible with the chassis member's holes.
3. Position the supports (pos. 5 and 6) to the bottom car's part and fix it through holes (pos. A) with bolts M10x40mm (pos. 8) from accessories.
4. Through the supports holes (pos. B) drill holes $\varnothing 12$ mm in the chassis members.
5. Put jibs with nuts (pos. 4) through the huge chassis member's holes and fix it with the supports through drilled holes using bolts M10x40mm
6. Cut the bumper and its cover (see supplied sketches).
7. Reassemble the bumper together with cover.
8. Position the ball of towing hitch (pos. 2) and fix with bolts M12x70mm (pos. 7) from the towing hitch accessories.
9. Fix the socket plate (pos. 3) as shown on the drawing.
10. Tighten all nuts and bolts according to the torque shown in the table.
11. Connect the electric wires according to the instructions of the car.
12. Complete the paint cover of towing hitch (during the mounting paint cover could be destroyed).

Torque settings for nuts and bolts (8,8):

M6 - 11 Nm	M8 - 25 Nm	M10 - 50 Nm
M12 - 87 Nm	M14 - 138 Nm	M16 - 210 Nm











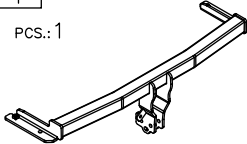



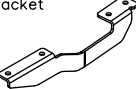

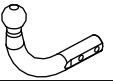
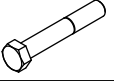
NOTE

After install the towing hitch you should get adequate note in registration book (at authorised service station). The car should be equipped with:

- Indicators
- Tow mirrors

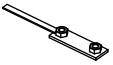
After 1000km of exploitation check all bolts and nuts. The ball of towing hitch must be always kept clear and conserve with a grease.

Towing hitch accessories:

Pos. 1 Main bar PCS.: 1	Pos. 5 Left bracket PCS.: 1	Pos. 10 Nut 8 B M12 PCS.: 2	Pos. 15 Plain washer ø8mm PCS.: 2
			
	Pos. 6 Right bracket PCS.: 1	Pos. 11 Nut 8 B M10 PCS.: 2	Pos. 16 Spring washer ø12mm PCS.: 2
			
Pos. 2 Tow ball PCS.: 1	Pos. 7 Bolt 8,8 B M12x70mm PCS.: 2	Pos. 12 Nut 8 B M8 PCS.: 1	Pos. 17 Spring washer ø10mm PCS.: 8
			
Pos. 3 Socket plate PCS.: 1	Pos. 8 Bolt 8,8 B M10x40mm PCS.: 8	Pos. 13 Plain washer ø12mm PCS.: 2	Pos. 18 Spring PCS.: 1
			
Pos. 4 Jib with nuts PCS.: 2	Pos. 9 Bolt 8,8 B M8x30mm PCS.: 1	Pos. 14 Plain washer ø10mm PCS.: 8	Pos. 19 Ball cover PCS.: 1
			



PPUH AUTO-HAK Sp.J.

Produkcja Zaczepów Kulowych
Henryk & Zbigniew Nejman
76-200 SŁUPSK ul. Słoneczna 16K
tel/fax (059) 8-414-414; 8-414-413
E-mail: office@autohak.com.pl
www.autohak.com.pl

Towing hitch (without electrical set)

Class: **A50-X** Cat. no. **K22**

Designed for:

VW POLO Classic, 4 doors (6N)

produced since 10.1995 till 09.1999

VW POLO Classic, 4 doors (6N2)

produced since 10.1999 till 09.2003

VW POLO Variant, Estale (6N)

produced since 04.1997 till 09.1999

produced since 10.1999 till 09.2001

SEAT CORDOBA 2/4 doors, Coupe, (6K5), CLX, GLX, GTI, SX

produced since 02.1996 till 09.1999

produced since 10.1999 till 12.2002

SEAT CORDOBA Vario, Estale (6K5)

produced since 09.1997 till 09.1999

produced since 10.1999 till 12.2002

Technical data:

D-value: 6,70 kN

maximum trailer weight: **1200 kg**

maximum vertical cup load: **50 kg**

Approval number acc. to regulations EKG/ONZ 55.01: E20-55R-01 0838

Foreword

This towing hitch is designed according to rules of safety traffic regulations. The towing hitch is a safety component and can be install only by qualified personnel. Any alteration or conversion of the towing hitch is prohibited and would lead to cancellation of design certification. Remove insulating compound and underseal from vehicle (if present) in the area of the matting surfaces of the towing hitch.

The vehicle manufacturer's specifications regarding trailer load and max. vertical cup load are decisive for driving whereat values for the towing hitch cannot be exceeded.

D-value formula:

$$\frac{\text{Max trailer weight [kg]} \times \text{Max vehicle weight [kg]}}{\text{Max trailer weight [kg]} + \text{Max vehicle weight [kg]}} \times \frac{9,81}{1000} = D \text{ [kN]}$$



PPUH AUTO-HAK S.J.

Produkcja Haków Holowniczych
Henryk & Zbigniew Nejman
76-200 SŁUPSK ul. Słoneczna 16K
tel/fax (059) 8-414-414; 8-414-413
e-mail: office@autohak.com.pl
[www. autohak.com.pl](http://www.autohak.com.pl)

Templates for towbar catalogue number **K 22**

designed for:

VW POLO Classic

produced since 1996 till 2000

VW POLO Variant

produced since 1997 till 2000

SEAT CORDOBA

2/4 doors CLX, GLX, GTI, SX, Coupe

produced since 02.1996 till 12.2002

SEAT CORDOBA Vario

produced since 1997 till 12.2002

BUMPER

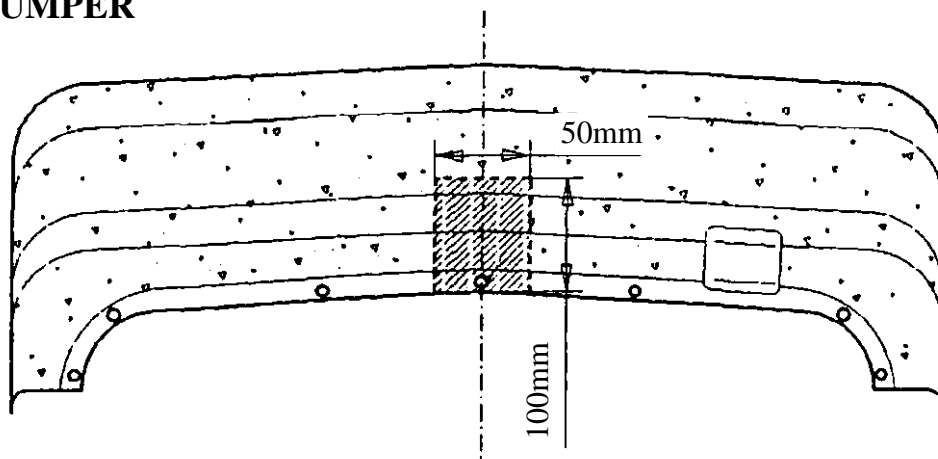

COVER

