

## FITTING INSTRUCTION

Clamp mark in acc. with		Cables joining
ISO	PN	
1	L	Left directional lights
2	+	Rear fog lights
3	31	Ground
4	R	Right directional lights
5	58R	Right side parking lights
6	54	Stoplights
7	58L	Left side parking lights

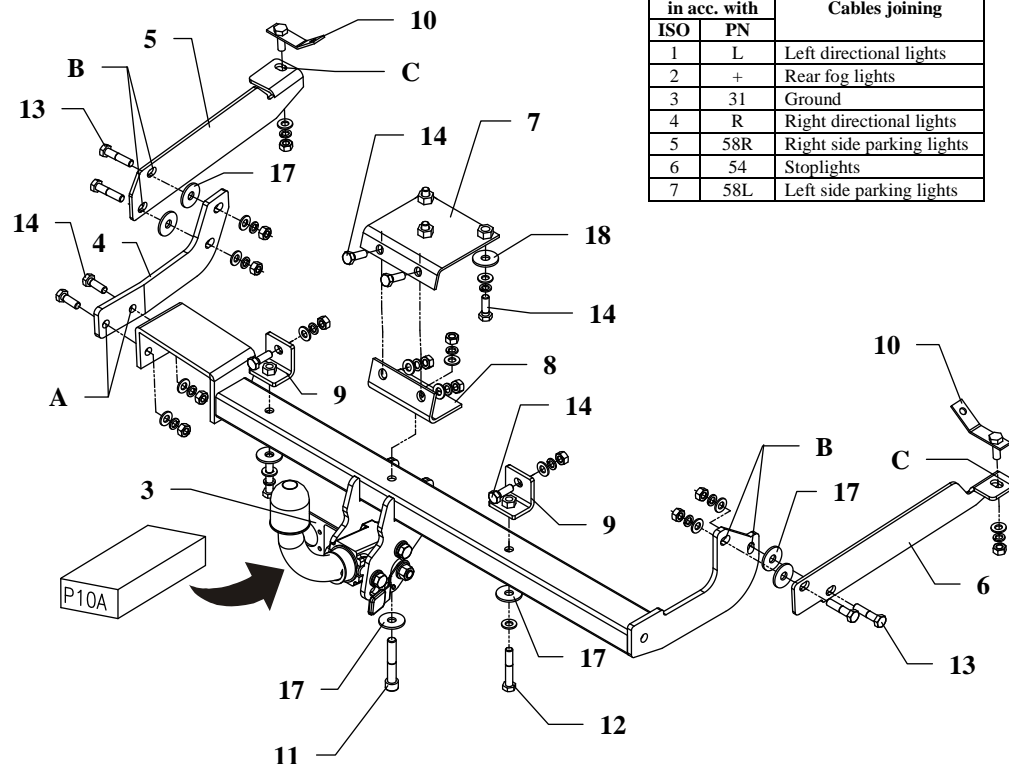

This towbar is designed to assembly in following cars:  
**CITROEN XSARA, 3/5 doors (N1)**, produced since 04.1997 till 03.2005,  
 catalogue no. **P10A** and is prepared to tow trailers max total weight **1300 kg** and max vertical load **70 kg**.

### *From manufacturer*

Thank you for buying our product. Their reliability has been confirmed in many tests. Reliability of towbar depends also on correct assembly and right operation. For this reasons we kindly ask to read carefully this instruction and apply to hints.

*The towbar should be install in points described by a car producer.*

## The instruction of the assembly

1. Take out the fitted carpet and the spare wheel from boot, disassemble two plastic plugs from left and right side.
2. Underneath fix upper plate (pos. 7) to the cross beam of the car using bolts M10x30mm (pos. 14), use big washers  $\varnothing 35 \times \varnothing 12 \times 4 \text{mm}$  (pos. 17).
3. Fix side handles (pos. 9) using bolts M10x30mm (pos. 14).
4. Fix bottom plate (pos. 8) to the upper plate (pos. 9) using two bolts M10x30mm (pos. 14).
5. Put main bar of the towbar (pos. 1) to fixed elements (pos. 7, 8 and 9) and fix it with bolts M10x70mm (pos. 12) and with cylinder head cap bolt (imbus) M12x70mm (pos. 11), use big washers  $\varnothing 35 \times \varnothing 12 \times 4 \text{mm}$  (pos. 17).
6. At points A fix left bracket (pos. 4) using bolts M10x30mm (pos. 14).
7. At points B fix jibs (pos. 5 and 6) using bolts M10x40mm (pos. 13) and big washers  $\varnothing 35 \times \varnothing 12 \times 4 \text{mm}$  (pos. 17)
8. Fix body of the automat and place tow-ball according to supplied instruction. Note! Remember to place socket plate (pos. 3) as shown on the drawing 1.
9. Fix bolts on the jib (pos. 10) at points C.  
**ATTENTION!** After disassemble plastic plugs (see point 1) you will find holes, through you should put bolts on the jib (pos. 10).
10. Tighten all bolts according to the torque shown in the table.
11. Connect electric wires of 7-poles socket according to the instruction of the car. (Recommend to make at authorized service station).
12. Complete paint layer damaged during installation.

Torque settings for nuts and bolts (8,8):	
<b>M 8</b> - 25 Nm	<b>M 10</b> - 55 Nm
<b>M 12</b> - 85 Nm	<b>M 14</b> - 135 Nm











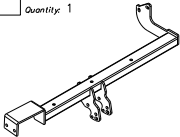



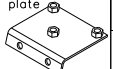





### NOTE

After install the towbar you should get adequate note in registration book (at authorised service station). The car should be equipped with:

- Indicators
- Tow mirrors

After 1000km check all bolts and nuts. The ball of towbar must be always kept clear and conserve with a grease.

## Towbar accessories:

Pos. 1 Name: Main bar Quantity: 1 	Pos. 6 Name: Right jib Quantity: 1 	Pos. 12 Name: Bolt 8,8 B Quantity: 2 Dim.: M10x70mm 	Pos. 18 Name: Plain washer Quantity: 2 Dim.: Ø 13 mm 
Pos. 2 Name: Tow ball Quantity: 1 	Pos. 7 Name: Upper plate Quantity: 1 	Pos. 13 Name: Bolt 8,8 B Quantity: 4 Dim.: M10x40mm 	Pos. 19 Name: Plain washer Quantity: 17 Dim.: Ø 10,5 mm 
Pos. 3 Name: Socket plate Quantity: 1 	Pos. 8 Name: Bottom plate Quantity: 1 	Pos. 14 Name: Bolt 8,8 B Quantity: 9 Dim.: M10x30mm 	Pos. 20 Name: Spring washer Quantity: 1 Dim.: Ø 12,2 mm 
Pos. 4 Name: Left bracket Quantity: 1 	Pos. 9 Name: Side handle Quantity: 2 	Pos. 15 Name: Nut 8 B Quantity: 1 Dim.: M12 	Pos. 21 Name: Spring washer Quantity: 17 Dim.: Ø 10,2 mm 
Pos. 5 Name: Left jib Quantity: 1 	Pos. 10 Name: Bolt with the jib Quantity: 2 	Pos. 16 Name: Nut 8 B Quantity: 12 Dim.: M10 	
	Pos. 11 Name: Bolt 8,8 B IMBUS Quantity: 1 Dim.: M12x70mm 	Pos. 17 Name: Washer Quantity: 10 Dim.: Ø35xØ12x4mm 	



## PPUH AUTO-HAK S.J.

Produkcja Haków Holowniczych  
Henryk & Zbigniew Nejman  
76-200 SŁUPSK ul. Słoneczna 16K  
tel/fax (059) 8-414-414; 8-414-413  
E-mail: [office@autohak.com.pl](mailto:office@autohak.com.pl)  
[www.autohak.com.pl](http://www.autohak.com.pl)

## Towing hitch (without electrical set)

Class: **A50-X** Cat. no. **P10A**

Designed for:

Manufacturer: **CITROEN**

Model: **XSARA**

Type: **3/5 doors (N1)**

produced since 04.1997 till 03.2005

Technical data:

**D-value: 7,16 kN**

maximum trailer weight: **1300 kg**

maximum vertical cup load: **70 kg**

**Approval number acc. to regulations EKG/ONZ 55.01: E20-55R-01 4192**

## Foreword

This towbar is designed according to rules of safety traffic regulations. The towing hitch is a safety component and can be install only by qualified personnel. Any alteration or conversion of the towing hitch is prohibited and would lead to cancellation of design certification. Remove insulating compound and underseal from vehicle (if present) in the area of the matting surfaces of the towing hitch. The vehicle manufacturer's specifications regarding trailer load and max. vertical cup load are decisive for driving whereat values for the towing hitch cannot be exceeded.

*D-value formula:*

$$\frac{\text{Max trailer weight [kg]} \times \text{Max vehicle weight [kg]}}{\text{Max trailer weight [kg]} + \text{Max vehicle weight [kg]}} \times \frac{9,81}{1000} = D \text{ [kN]}$$