

FITTING INSTRUCTION

Clamp mark in acc. with		Cables joining
ISO	PN	
1	L	Left directional lights
2	+	Rear fog lights
3	31	Ground
4	R	Right directional lights
5	58R	Right side parking lights
6	54	Stoplights
7	58L	Left side parking lights

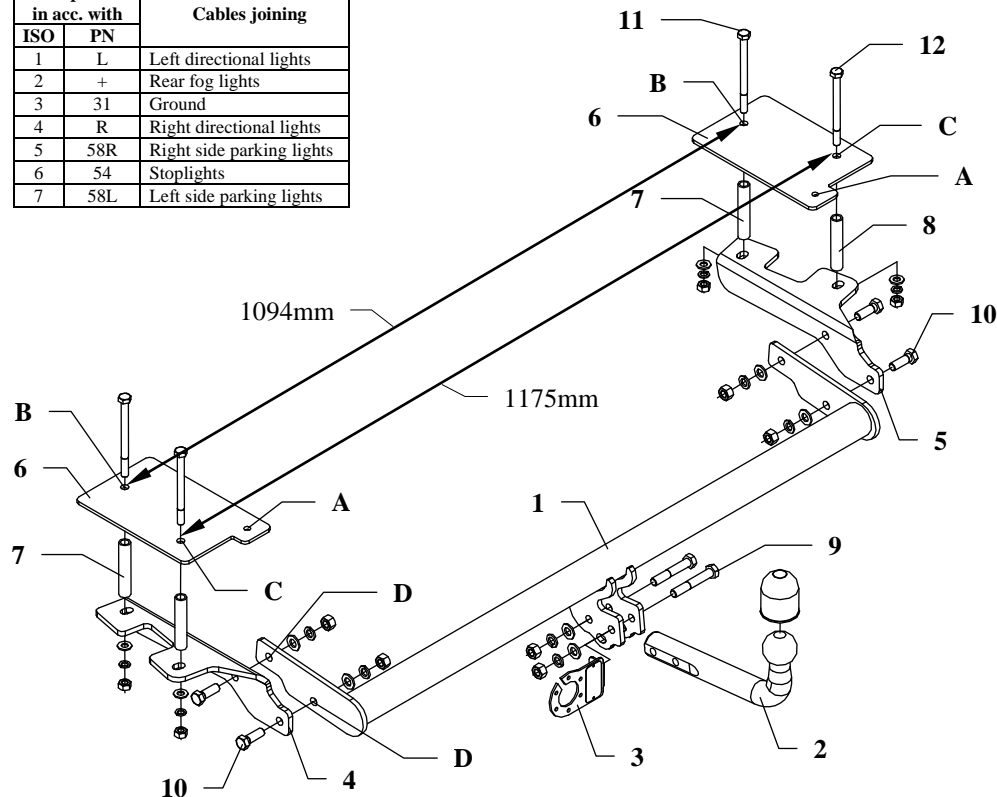

This towing hitch is designed to assembly in following cars:
FIAT PALIO WEEKEND ESTATE (178), produced since 01.1998 till 10.2003, catalogue no. **R15** and is prepared to tow trailers max total weight **1200 kg** and max vertical mass **70 kg**.

From manufacturer

Thank you for buying our product. Their reliability has been confirmed in many tests. Reliability of towing hitch depends also on correct assembly and right operation. For this reasons we kindly ask to read carefully this instruction and apply to hints.

The towing hitch should be install in points described by a car producer.

The instruction of the assembly

- For the purpose of the installings of the towing hitch is not necessary to disassemble the bumper and cut-out any of its fragments.
- Take out the spare wheel, and unscrew the carpets from the floor and sides in the interior of the carrier.
- Unscrew the towing eye designed by the manufacturer (it will not be used again).
- Apply the fish-plates (pos. 6) to the inside the carrier, on the right and left sides and fix through the holes A. Use bolts M8 from shanks fixing the carrier.
- Place the fish-plates in accordance with the dimensions on the drawing. Mark this points. Drill to $\varnothing 11\text{mm}$ across holes B and C. Drill perpendicular to the floor and the chassis.
- Unscrew the fish-plates. Drill through $\varnothing 17,5\text{mm}$ the previously bored holes B and C.
- Apply the distance sleeves $L=90\text{mm}$ in the holes B, and the distance sleeves $L=86\text{mm}$ in the holes C.
- Apply again the fish-plates to the holes B and use bolts M10x130mm (pos. 11), and on the holes C use bolts M10x120mm (pos. 12). From under the car apply the brackets (pos. 4 and 5). Fix lightly. The bracket with cut out on the left side.
- Fix the main bar of the towing hitch (pos. 1) to installed brackets with M12x35mm (pos. 10) bolts by the holes D.
- Fix tow ball (pos. 2) using bolt M12x75mm (pos. 9) and M12x70mm (pos. 19). With bolt M12x75mm fix also a socket plate (pos. 3). See figure 1.
- Tighten all bolts according to the torque shown in the table.
- Connect electric wires of 7-poles socket according to the instruction of the car. (Recommend to make at authorized service station).
- Complete paint layer damaged during installation.

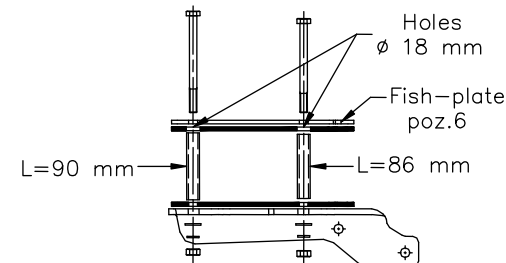

Torque settings for nuts and bolts (8,8):	
M 8 - 25 Nm	M 10 - 55 Nm
M 12 - 85 Nm	M 14 - 135 Nm







NOTE

After install the towing hitch you should get adequate note in registration book (at authorised service station). The car should be equipped with:

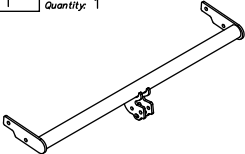
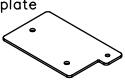
- Indicators
- Tow mirrors

After 1000km check all bolts and nuts. The ball of towing hitch must be always kept clear and conserve with a grease.

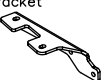
Towing hitch accessories:

Pos. 1 Name: Main bar Quantity: 1	Pos. 5 Name: Right bracket Quantity: 1	Pos. 10 Name: Bolt 8,8 B Quantity: 4 Dim.: M12x35mm	Pos. 15 Name: Plain washer Quantity: 6 Dim.: Ø 13 mm
	Pos. 6 Name: Fish-plate Quantity: 2	Pos. 11 Name: Bolt 8,8 B Quantity: 2 Dim.: M10x130mm	Pos. 16 Name: Plain washer Quantity: 4 Dim.: Ø 10,5 mm
	Pos. 7 Name: Distance sleeve Quantity: 2 Dim.: Ø17,2x2,35mm L=90mm	Pos. 12 Name: Bolt 8,8 B Quantity: 2 Dim.: M10x120mm	Pos. 17 Name: Spring washer Quantity: 6 Dim.: Ø 12,2 mm
	Pos. 8 Name: Distance sleeve Quantity: 2 Dim.: Ø17,2x2,35mm L=86mm	Pos. 13 Name: Nut 8 B Quantity: 6 Dim.: M12	Pos. 18 Name: Spring washer Quantity: 4 Dim.: Ø 10,2 mm
	Pos. 3 Name: Socket plate Quantity: 1	Pos. 14 Name: Nut 8 B Quantity: 4 Dim.: M10	Pos. 19 Name: Bolt 8,8 B Quantity: 1 Dim.: M12x70mm
	Pos. 4 Name: Left bracket Quantity: 1	Pos. 9 Name: Bolt 8,8 B Quantity: 1 Dim.: M12x75mm	Pos. 20 Name: Ball cover Quantity: 1
			



PPUH AUTO-HAK S.J.

Produkcja Zaczepów Kulowych
Henryk & Zbigniew Nejman
76-200 SŁUPSK ul. Słoneczna 16K
tel/fax (059) 8-414-414; 8-414-413
E-mail: office@autohak.com.pl
www.autohak.com.pl

Towing hitch (without electrical set)

Class: **A50-X** Cat. no. **R15**

Designed for:

Manufacturer: **FIAT**

Model: **PALIO WEEKEND**

Type: **ESTATE (178)**

produced since 01.1998 till 10.2003

Technical data:

D-value: 6,9 kN

maximum trailer weight: **1200 kg**

maximum vertical cup mass: **70 kg**

Approval number acc. to regulations EKG/ONZ 55.01: E20-55R-01 1152

Foreword

This towing hitch is designed according to rules of safety traffic regulations. The towing hitch is a safety component and can be install only by qualified personnel. Any alteration or conversion of the towing hitch is prohibited and would lead to cancellation of design certification. Remove insulating compound and underseal from vehicle (if present) in the area of the matting surfaces of the towing hitch. The vehicle manufacturer's specifications regarding trailer mass and max. vertical cup mass are decisive for driving whereat values for the towing hitch cannot be exceeded.

D-value formula:

$$\frac{\text{Max trailer weight [kg]} \times \text{Max vehicle weight [kg]}}{\text{Max trailer weight [kg]} + \text{Max vehicle weight [kg]}} \times \frac{9,81}{1000} = D \text{ [kN]}$$