

## FITTING INSTRUCTION

Clamp mark in acc. with		Cables joining
ISO	PN	
1	L	Left directional lights
2	+	Rear fog lights
3	31	Ground
4	R	Right directional lights
5	58R	Right side parking lights
6	54	Stoplights
7	58L	Left side parking lights

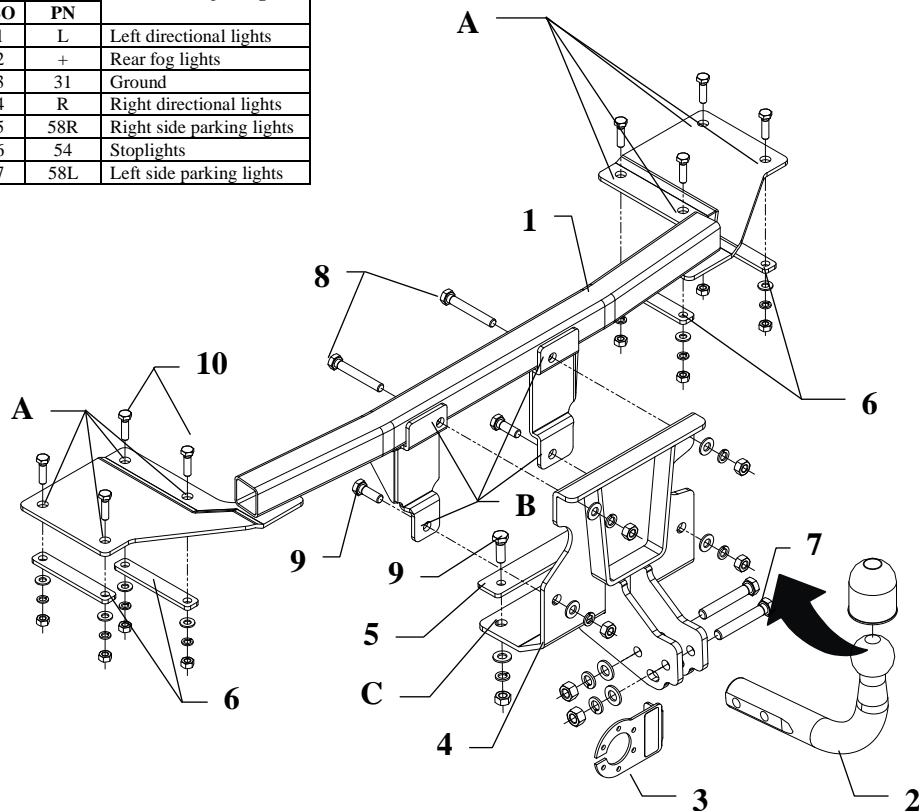

This towbar is designed to assembly in following cars:  
**FIAT ALBEA, 4 doors**, produced since 2002, catalogue no. **R32** and is prepared to tow trailers max total weight **1300 kg** and max vertical load **50 kg**.

### *From manufacturer*

Thank you for buying our product. Their reliability has been confirmed in many tests. Reliability of towbar depends also on correct assembly and right operation. For this reasons we kindly ask to read carefully this instruction and apply to hints.

*The towbar should be install in points described by a car producer.*

## Fitting instructions

1. Take the spare wheel out the car.
2. Disassemble the bumper.
3. Put horizontally the main bar of the towbar (pos. 1) to the trunk (it should be position close to the rear panel).
4. Drill  $\varnothing 9\text{mm}$  through the holes (pos. A), then fix it together with the fish-plates (pos. 6) positioned at the bottom of the car using bolts M8x30mm (pos. 10).
5. Drill  $\varnothing 11\text{mm}$  through the holes (pos. B), then position ball bracket (pos. 4) to the rear panel and fix it using bolts M10x70mm – pos. 8 (top) and M10x30mm – pos. 9 (bottom).
6. Drill  $\varnothing 11\text{mm}$  through the towbar holes (pos. C) at the bottom of the car and then fix it together with the fish-plate (pos. 5) – this fish-plate should be position in the trunk.
7. Cut the bumper (dimension 50x60mm).
8. Reassemble the bumper.
9. Tighten all nuts and bolts according to the torque shown in the table.
10. Position the ball of towbar (pos. 2) with socket plate (pos. 3) and fix it with M12x75mm (pos. 7) bolts from the towbar accessories.
11. Connect to the electric wires according to the instructions of the car.
12. Complete the paint cover of towbar (during the mounting paint cover could be destroyed).

Torque settings for nuts and bolts (8,8):	
<b>M 8</b> - 25 Nm	<b>M 10</b> - 55 Nm
<b>M 12</b> - 85 Nm	<b>M 14</b> - 135 Nm











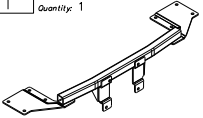
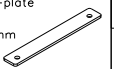





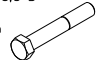

### NOTE

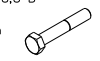
After install the towbar you should get adequate note in registration book (at authorised service station).The car should be equipped with:

- Indicators
- Tow mirrors

After 1000km check all bolts. The ball of towbar must be always kept clear and conserve with a grease.

## Towbar accessories:

Pos. 1 Name: Main bar Quantity: 1 	Pos. 5 Name: Fish-plate Quantity: 1 Dim.: 240x35x5mm 	Pos. 10 Name: Bolt 8,8 B Quantity: 8 Dim.: M8x30mm 	Pos. 15 Name: Plain washer Quantity: 6 Dim.: Ø 10,5 mm 
	Pos. 6 Name: Fish-plate of the bracket Quantity: 4 Dim.: 120x20x5mm 	Pos. 11 Name: Nut 8 B Quantity: 2 Dim.: M12 	Pos. 16 Name: Plain washer Quantity: 8 Dim.: Ø 8,5 mm 
Pos. 2 Name: Tow ball Quantity: 1 	Pos. 7 Name: Bolt 8,8 B Quantity: 2 Dim.: M12x75mm 	Pos. 12 Name: Nut 8 B Quantity: 6 Dim.: M10 	Pos. 17 Name: Spring washer Quantity: 2 Dim.: Ø 12,2 mm 
Pos. 3 Name: Socket plate Quantity: 1 	Pos. 8 Name: Bolt 8,8 B Quantity: 2 Dim.: M10x70mm 	Pos. 13 Name: Nut 8 B Quantity: 8 Dim.: M8 	Pos. 18 Name: Spring washer Quantity: 6 Dim.: Ø 10,2 mm 
Pos. 4 Name: Ball bracket Quantity: 1 	Pos. 9 Name: Bolt 8,8 B Quantity: 4 Dim.: M10x30mm 	Pos. 14 Name: Plain washer Quantity: 2 Dim.: Ø 13 mm 	Pos. 19 Name: Spring washer Quantity: 8 Dim.: Ø 8,2 mm 
		Pos. 20 Name: Ball cover Quantity: 1 	



**PPUH AUTO-HAK S.J.**

Produkcja Haków Holowniczych  
Henryk & Zbigniew Nejman  
76-200 SŁUPSK ul. Słoneczna 16K  
tel/fax (059) 8-414-414; 8-414-413  
E-mail: [office@autohak.com.pl](mailto:office@autohak.com.pl)  
[www.autohak.com.pl](http://www.autohak.com.pl)

## Towing hitch (without electrical set)

Class: **A50-X** Cat. no. **R32**

Designed for:

Manufacturer: **FIAT**

Model: **ALBEA**

Type: **4 doors**

produced since 2002

Technical data:

**D-value: 6,88 kN**

maximum trailer weight: **1300 kg**

maximum vertical cup load: **50 kg**

**Approval number acc. to regulations EKG/ONZ 55.01: E20-55R-01 0784**

## Foreword

This towbar is designed according to rules of safety traffic regulations. The towing hitch is a safety component and can be install only by qualified personnel. Any alteration or conversion of the towing hitch is prohibited and would lead to cancellation of design certification. Remove insulating compound and underseal from vehicle (if present) in the area of the matting surfaces of the towing hitch.

The vehicle manufacturer's specifications regarding trailer load and max. vertical cup load are decisive for driving whereat values for the towing hitch cannot be exceeded.

*D-value formula:*

$$\frac{\text{Max trailer weight [kg]} \times \text{Max vehicle weight [kg]}}{\text{Max trailer weight [kg]} + \text{Max vehicle weight [kg]}} \times \frac{9,81}{1000} = D \text{ [kN]}$$