

FITTING INSTRUCTION

| Clamp mark in acc. with | | Cables joining |
|-------------------------|-----|---------------------------|
| ISO | PN | |
| 1 | L | Left directional lights |
| 2 | + | Rear fog lights |
| 3 | 31 | Ground |
| 4 | R | Right directional lights |
| 5 | 58R | Right side parking lights |
| 6 | 54 | Stoplights |
| 7 | 58L | Left side parking lights |

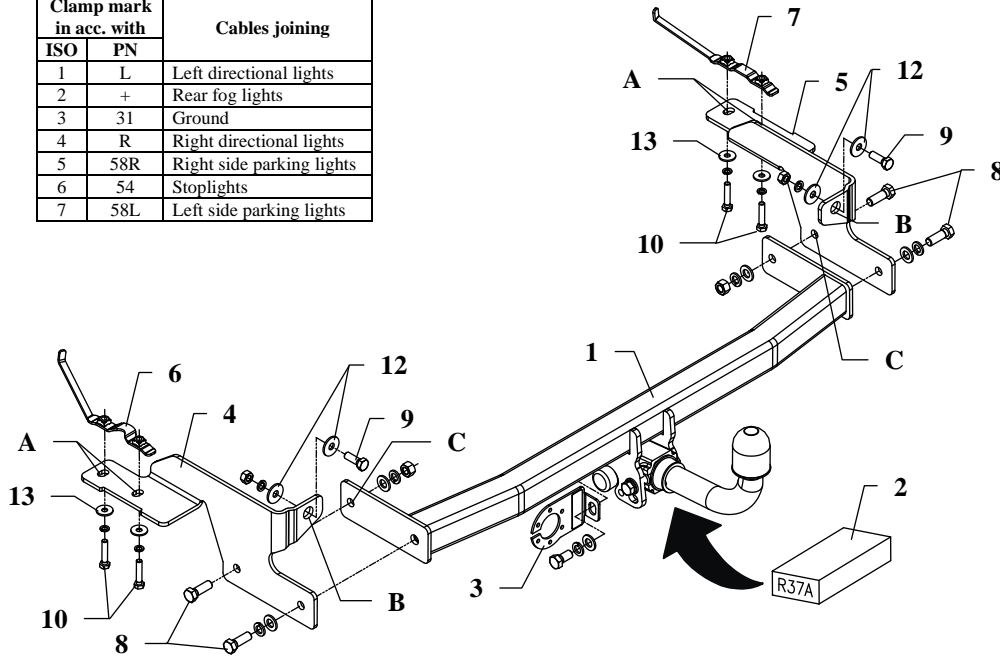

This towing hitch is designed to assembly in following cars:
FIAT IDEA, VAN produced since 01.2004, catalogue no. **R37A** and is prepared to tow trailers max total weight **1100 kg** and max vertical load **60 kg**.

From manufacturer

Thank you for buying our product. Their reliability has been confirmed in many tests. Reliability of towing hitch depends also on correct assembly and correct exploitation. For this reasons we kindly ask to read carefully this instruction and apply to hints.

The towing hitch should be install in points described by a car producer.

The instruction of the assembly

1. Disassemble a rear bumper.
2. Get lower a muffler, disassemble muffler's handle and thermal shield.
3. Take out plastic plugs from chassis members, distance 70mm.
4. Find under anti-noise mat in boot longitudinal holes on the left and right side (endmost of a car). To this holes put handles with nuts (pos. 6 and 7).
5. Left bracket (pos. 4) fix to the left chassis member and right bracket (pos. 5) fix to right chassis member through holes pos. A with handles (pos. 6 and 7). Next fix to body through holes pos. B
6. Drill holes pos. C (in frame brackets) using bit $\varnothing 12,5\text{mm}$.
7. To in this way prepared brackets (pos. 4 and 5) fix main bar of the towing hitch (pos. 1) using bolts M12x35mm (pos. 8).
8. Reassemble the bumper after cut out fragments according to figure 2.

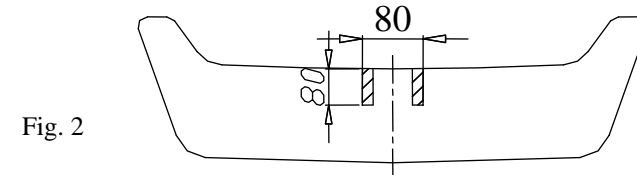

9. Fix body of the automat and place tow-ball according to supplied instruction. Note! Remember to place socket plate (pos. 3) as shown on the drawing 1.
10. Tighten all bolts according to the torque shown in the table.
11. Connect electric wires of 7-poles socket according to the instruction of the car. (Recommend to make at authorized service station)
12. Complete paint layer damaged during installation

| | |
|---|----------------------|
| Torque settings for nuts and bolts (8,8): | |
| M 8 - 25 Nm | M 10 - 55 Nm |
| M 12 - 85 Nm | M 14 - 135 Nm |











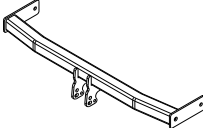
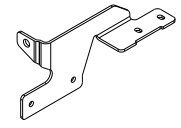





NOTE

After install the towing hitch you should get adequate note in registration book (at authorised service station).The car should be equipped with:

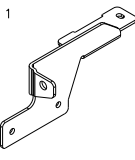
- Indicators
- Tow mirrors

After 1000km check all bolts and nuts. The ball of towing hitch must be always kept clear and conserve with a grease.

Towing hitch accessories:

| | | | |
|--|---|---|---|
| Pos. 1 Name: Main bar Quantity: 1  | Pos. 5 Name: Right bracket Quantity: 1  | Pos. 10 Name: Bolt 8,8 B Quantity: 4 Dim.: M8x40mm  | Pos. 16 Name: Spring washer Quantity: 4 Dim.: Ø 8,2 mm  |
| Pos. 2 Name: Tow ball Quantity: 1  | Pos. 6 Name: Left handle Quantity: 1  | Pos. 11 Name: Plain washer Quantity: 4 Dim.: Ø 13 mm  | Pos. 17 Name: Nut 8 B Quantity: 2 Dim.: M12  |
| Pos. 3 Name: Socket plate Quantity: 1  | Pos. 7 Name: Right handle Quantity: 1  | Pos. 12 Name: Washer Quantity: 8 Dim.: Ø30xØ10,5x2,5mm  | Pos. 18 Name: Nut 8 B Quantity: 2 Dim.: M10  |
| Pos. 4 Name: Left bracket Quantity: 1  | Pos. 8 Name: Bolt 8,8 B Quantity: 4 Dim.: M12x35 mm  | Pos. 13 Name: Washer Quantity: 8 Dim.: Ø24xØ8,4x2mm  | Pos. 19 Name: Ball cover Quantity: 1  |
| | Pos. 9 Name: Bolt 8,8 B Quantity: 2 Dim.: M10x30mm  | Pos. 14 Name: Spring washer Quantity: 4 Dim.: Ø 12,2 mm  | |
| | Pos. 15 Name: Spring washer Quantity: 2 Dim.: Ø 10,2 mm  | | |



PPUH AUTO-HAK S.J.

Produkcja Haków Holowniczych
Henryk & Zbigniew Nejman
76-200 SŁUPSK ul. Słoneczna 16K
tel/fax (059) 8-414-414; 8-414-413
E-mail: office@autohak.com.pl
www. autohak.com.pl

Towing hitch (without electrical set)

Class: **A50-X** Cat. no. **R37A**

Designed for:

Manufacturer: **FIAT**

Model: **IDEA**

Type: **VAN**

produced since 01.2004

Technical data:

D-value: 6,8 kg

maximum trailer weight: **1100 kg**

maximum vertical cup load: **60 kg**

Approval number acc. to regulations EKG/ONZ 55.01: E20-55R-01 1773

Foreword

This towing hitch is designed according to rules of safety traffic regulations. The towing hitch is a safety component and can be install only by qualified personnel. Any alteration or conversion of the towing hitch is prohibited and would lead to cancellation of design certification. Remove insulating compound and underseal from vehicle (if present) in the area of the matting surfaces of the towing hitch.

The vehicle manufacturer's specifications regarding trailer load and max. vertical cup load are decisive for driving, and values for the towing hitch cannot be exceeded.

D-value formula:

$$\frac{\text{Max trailer weight [kg]} \times \text{Max vehicle weight [kg]}}{\text{Max trailer weight [kg]} + \text{Max vehicle weight [kg]}} \times \frac{9,81}{1000} = D \text{ [kN]}$$