

FITTING INSTRUCTION

Clamp mark in acc. with		Cables joining
ISO	PN	
1	L	Left directional lights
2	+	Rear fog lights
3	31	Ground
4	R	Right directional lights
5	58R	Right side parking lights
6	54	Stoptlights
7	58L	Left side parking lights

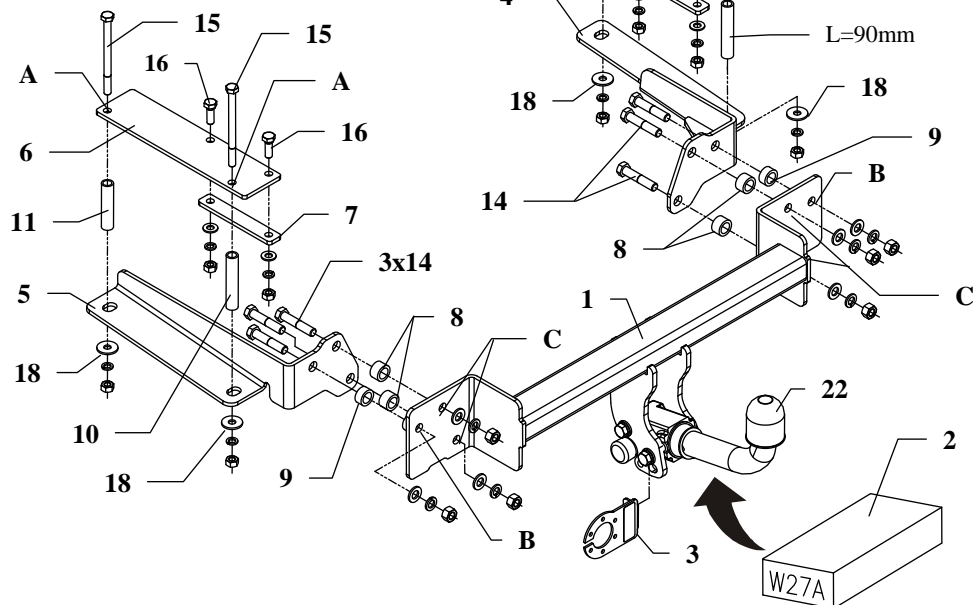

This towing hitch is designed to assembly in following car: **SUZUKI SX4 4 DOORS**, produced since 11.2007 till 09.2013, catalogue number **W27A** and is prepared to tow trailers max total weight **1200 kg** and max vertical mass **50 kg**.

From manufacturer

Thank you for buying our product. Their reliability has been confirmed in many tests. Reliability of towing hitch depends also on correct assembly and right operation. For this reasons we kindly ask to read carefully this instruction and apply to hints.

The towing hitch should be install in points described by a car producer.

The instruction of the assembly

1. Disassemble bumper together with its metal reinforcement.
2. Underneath a car find existing holes A and rill it using pin $\varnothing 1$ mm to trunk
3. From inside trunk enlarge made holes to diameter ca. $\varnothing 18$ mm.
4. To enlarged holes (in trunk) slip distance sleeves according to figure, next apply bog fish-plates (pos. 6) and put bolts M10x130mm (pos. 13).
5. Underneath a car, on outstanding bolts apply side brackets (pos. 4 and 5) and fix loosely through big washers (pos. 16) by nuts M10.
6. Inside trunk drill rest of holes of fish-plates (pos. 6) by bit $\varnothing 11$ mm. Fix loosely by bolts M10x30mm (pos. 14) through applied underneath small fish-plates (pos. 7) as shown in the drawing.
7. Apply main bar of the towbar (pos. 1) to back wall of a car this way, so holes B agree with original prepared holes in rear wall and fix loosely by bolts M12x60mm (pos. 12). Remember about distance sleeves (pos. 9).
8. At points C drill holes in rear wall using bit $\varnothing 13$ mm.
9. Through drilled holes put bolts M12x60mm (pos. 12). Apply distance sleeves (pos. 8) and fix with main bar of the towbar as shown in the drawing.
10. Fix body of the automat and place tow-ball according to supplied instruction. Note! Remember to place socket plate (pos. 3) as shown on the drawing 1.
11. Tighten all bolts according to the torque shown in the table.
12. Reassemble bumper together with its metal reinforcement.
13. Connect electric wires of 7-poles socket according to the instruction of the car. (Recommend to make at authorized service station).
14. Complete paint layer damaged during installation.

Torque settings for nuts and bolts (8,8):

M 8 - 25 Nm	M 10 - 55 Nm
M 12 - 85 Nm	M 14 - 135 Nm











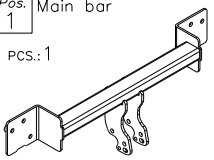
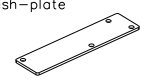



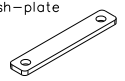
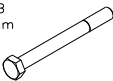

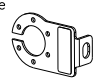



NOTE

After install the towing hitch you should get adequate note in registration book (at authorised service station). The car should be equipped with:

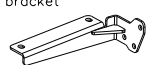
- Indicators
- Tow mirrors

After 1000km of exploitation check all bolts and nuts. The ball of towing hitch must be always kept clear and conserve with a grease.

Towing hitch accessories:

Pos. 1 Main bar PCS.: 1 	Pos. 6 Big fish-plate pcs.: 2 	Pos. 12 Bolt 8,8 B M12x60mm PCS.: 6 	Pos. 18 Spring washer ø12,2mm PCS.: 6 
Pos. 2 Tow ball pcs.: 1 	Pos. 7 Small fish-plate pcs.: 2 	Pos. 13 Bolt 8,8 B M10x130mm PCS.: 4 	Pos. 19 Spring washer ø10,2mm PCS.: 8 
Pos. 3 Socket plate pcs.: 1 	Pos. 8 Distance sleeve I ø25x4mm L=15mm PCS.: 4 	Pos. 14 Bolt 8,8 B M10x30mm PCS.: 4 	Pos. 20 Nut 8 B M12 PCS.: 6 
Pos. 4 Right bracket pcs.: 1 	Pos. 9 Distance sleeve II ø25x4mm L=12mm PCS.: 2 	Pos. 15 Plain washer ø13mm PCS.: 6 	Pos. 21 Nut 8 B M10 PCS.: 8 
Pos. 5 Left bracket pcs.: 1 	Pos. 10 Distance sleeve III ø17,2x2,35mm L=90mm PCS.: 2 	Pos. 16 Plain washer ø30xø10,5x2,5mm PCS.: 4 	Pos. 22 Ball cover PCS.: 1 
	Pos. 11 Distance sleeve IV ø17,2x2,35mm L=76mm PCS.: 2 	Pos. 17 Plain washer ø10,5mm PCS.: 4 	

Towing hitch (without electrical set)

Class: **A50-X** Cat. no. **W27A**

Designed for:

Manufacturer: **SUZUKI**

Model: **SX4**

Type: **4 doors**

produced since 11.2007 till 09.2013

Technical data:

D-value: 7,0 kN

maximum trailer weight: **1200 kg**

maximum vertical cup mass: **50 kg**

Approval number according to Directive 94/20/EC: **e20*94/20*0685*00**

Foreword

This towing hitch is designed according to rules of safety traffic regulations. The towing hitch is a safety component and can be install only by qualified personnel. Any alteration or conversion of the towing hitch is prohibited and would lead to cancellation of design certification. Remove insulating compound and underseal from vehicle (if present) in the area of the matting surfaces of the towing hitch. The vehicle manufacturer's specifications regarding trailer mass and max. vertical cup mass are decisive for driving whereat values for the towing hitch cannot be exceeded.

D-value formula:

$$\frac{\text{Max trailer weight [kg]} \times \text{Max vehicle weight [kg]}}{\text{Max trailer weight [kg]} + \text{Max vehicle weight [kg]}} \times \frac{9,81}{1000} = D \text{ [kN]}$$