

## FITTING INSTRUCTION

Clamp mark in acc. with		Cables joining
ISO	PN	
1	L	Left directional lights
2	+	Rear fog lights
3	31	Ground
4	R	Right directional lights
5	58R	Right side parking lights
6	54	Stoptlights
7	58L	Left side parking lights

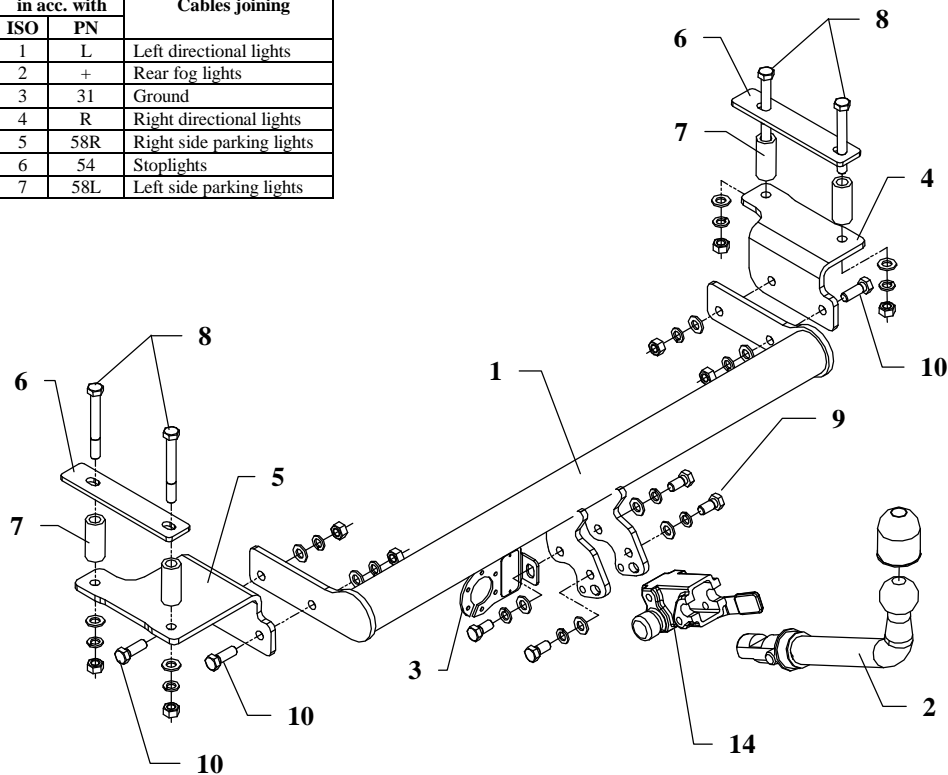

This towbar is designed to assembly in following cars:  
**DAEWOO LANOS, 4 doors**, produced since 1997 till 2003, catalogue number **X09A** and is prepared to tow trailers max total weight **1100 kg** and max vertical load **50 kg**.

### *From manufacturer*

Thank you for buying our product. Their reliability has been confirmed in many tests. Reliability of towbar depends also on correct assembly and right operation. For this reasons we kindly ask to read carefully this instruction and apply to hints.

*The towbar should be install in points described by a car producer.*

## The instruction of the assembly

1. Disassemble the rear plastic panel's cover in the boot.
2. Put the template "A" on supports of the boot (left and right side), then sign huge hole according to this template and drill it.
3. Underneath the car drill 12 mm through original holes (apparently 20 mm) of chassis members to the inside part of the boot (two holes per each side, do it very careful)
4. Enlarge this holes  $\varnothing 25$  mm (do it inside of the boot) and next slip to this holes distance sleeves, see fig. 2
5. Put fish-plates pos. 6 in that way so holes in fish-plates 6 agree to early made holes.
6. Put side brackets (pos. 4 and 5) at the bottom of car and fix it through distance sleeves (pos. 7) and fish-plates pos. 6 using bolts M12x100mm (pos. 8), see fig. 2.
7. Between installed side brackets (pos. 4 and 5) put main bar of the towbar (pos. 1) and fix it using bolts M12x35mm (pos. 10).
8. Install bumper (before installation cut out his fragment 20x80mm - in lower part), see sheet with template.
9. Reassemble rear plastic panel cover.
10. Fix body of the automat (pos. 14) and the socket plate (pos. 9) using bolts M12x25mm (pos. 4) from accessories. Place tow-ball (pos. 2) according to supplied instruction.
11. Tighten all bolts according to the torque shown in the table.
12. Connect electric wires of 7-poles socket according to the instruction of the car. (Recommend to make at authorized service station).
13. Complete paint layer damaged during installation.

Torque settings for nuts and bolts (8,8):	
<b>M 8</b> - 25 Nm	<b>M 10</b> - 55 Nm
<b>M 12</b> - 85 Nm	<b>M 14</b> - 135 Nm











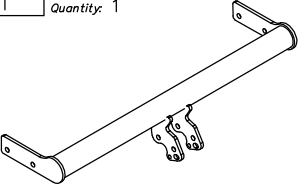
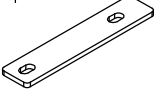

### NOTE

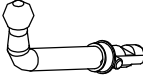
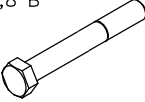
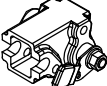
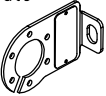
After install the towbar you should get adequate note in registration book (at authorised service station).The car should be equipped with:

- Indicators
- Tow mirrors

After 1000km of exploitation check all bolts and nuts. The ball of towbar must be always kept clear and conserve with a grease.

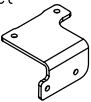
## Towbar accessories:

Pos. 1 Name: Main bar Quantity: 1 	Pos. 6 Name: Fish-plate Quantity: 2 	Pos. 12 Name: Plain washer Quantity: 12 Dim.: Ø 13 mm 
	Pos. 7 Name: Distance sleeve Quantity: 4 Dim.: Ø25xØ15mm L=57mm 	Pos. 13 Name: Spring washer Quantity: 12 Dim.: Ø 12,2 mm 
Pos. 2 Name: Tow ball Quantity: 1 	Pos. 8 Name: Bolt 8,8 B Quantity: 4 Dim.: M12x100mm 	Pos. 14 Name: Body of the automat Quantity: 1 
Pos. 3 Name: Socket plate Quantity: 1 	Pos. 9 Name: Bolt 8,8 B Quantity: 4 Dim.: M12x25mm 	Pos. 15 Name: Ball cover Quantity: 1 
Pos. 4 Name: Right bracket Quantity: 1 	Pos. 10 Name: Bolt 8,8 B Quantity: 4 Dim.: M12x35mm 	Pos. 16 Name: Body plug Quantity: 1 
Pos. 5 Name: Left bracket Quantity: 1 	Pos. 11 Name: Nut 8 B Quantity: 8 Dim.: M12 	



## PPUH AUTO-HAK S.J.

Produkcja Zaczepów Kulowych  
Henryk & Zbigniew Nejman  
76-200 SŁUPSK ul. Słoneczna 16K  
tel/fax (059) 8-414-414; 8-414-413  
E-mail: [office@autohak.com.pl](mailto:office@autohak.com.pl)  
[www.autohak.com.pl](http://www.autohak.com.pl)

## Towing hitch (without electrical set)

Class: A50-X Cat. no. X09A

Designed for:

Manufacturer: DAEWOO

Model: LANOS

Type: 4 doors

produced since 1997 till 2003

Technical data:

D-value: 6,4 kN

maximum trailer weight: 1100 kg

maximum vertical cup load: 50 kg

Approval number according to Directive 94/20/EC: **e20\*94/20\*0811\*00**

## Foreword

This towbar is designed according to rules of safety traffic regulations. The towing hitch is a safety component and can be install only by qualified personnel. Any alteration or conversion of the towing hitch is prohibited and would lead to cancellation of design certification. Remove insulating compound and underseal from vehicle (if present) in the area of the matting surfaces of the towing hitch.

The vehicle manufacturer's specifications regarding trailer load and max. vertical cup load are decisive for driving whereat values for the towing hitch cannot be exceeded.

D-value formula:

$$\frac{\text{Max trailer weight [kg]} \times \text{Max vehicle weight [kg]}}{\text{Max trailer weight [kg]} + \text{Max vehicle weight [kg]}} \times \frac{9,81}{1000} = D \text{ [kN]}$$